

ERGO WORK

SWIVEL ARMS PRO SERIES

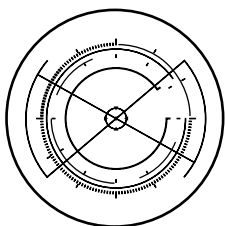

The Ergo Work **swivel arms** increase the storage space available to the operator on workbenches and trolleys. You can choose between two different types of arms: the first can be installed directly on the **upright** of the equipped wall, while the second is fixed onto the **worktop**. Thanks to its wide rotation angle, the position of the arm can be easily adjusted so as to have everything to hand and make the workstation increasingly ergonomic. Ergo Work can accommodate trays, monitor support plates, solutions with containers and perforated panels.



CONFIGURABLE

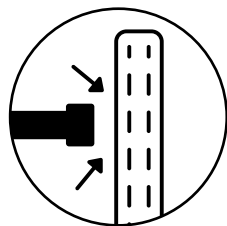

MOUNTING ON
UPRIGHTS

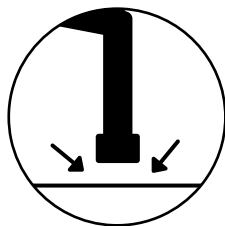

MOUNTING ON
WORKTOP



LOAD-BEARING
CAPACITY 20 KG

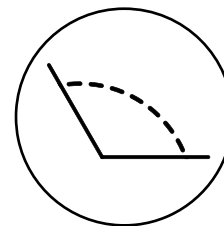

ROTATION ANGLE
240-260°



CONFIGURE 

PATENTED*

ART.	W mm	D mm	H mm	KG	RAL
DYNAMIC1506	1497/3139	780	1983/2383	400	7035+7016

Made up of:

qty.	description	qty.	description
1	Electrically adjustable unassembled workbench	1	Schuko 4-socket power strip
1	Cabinet W=500 mm with 1 drawer H=150 mm	2	Schuko 2-socket power strip
1	Cover for cabinet W=500 mm	1	USB charging port
1	Pair of supports for cabinet	1	USB data port
1	Additional power strip frame with end caps and corner elements	1	Wieland Schuko/FR connection cable
1	Kit with 2 dual-slotted uprights for workbenches	1	Glove dispenser
1	Kit with 2 inclined supports with track	1	Reversible sanitiser-bottle holder
1	Double lamp	36	Picking Box Air polypropylene Bin size 2
1	Supplementary track with fittings	4	Swivel arm for upright
1	Compressed air set with flow balancing device and filter	1	Joint for plate
2	Perforated panel/shelf with box-stop edge	3	Monitor support plate with VESA standard
3	Single lamp	1	Panel for Picking Box
1	Perforated panel/shelf	3	Bar mount for Picking Box bins size 1/2
1	Electric perforated panel	3	Kit of 4 Picking Box Air bins size 1
2	Unipok tool hook - 30-piece pack	1	Panel for Visual Box
1	Differential magnetic-thermal circuit breaker	2	Visual Box cabinet with 6 drawers
1	Inclined tray	1	Visual Box cabinet with 5 drawers



LOAD CAPACITY RAL 7035 + RAL 7016



SWIVEL ARM WITH PICKING BOX

ART.	W mm	D mm	H mm	RAL	
ERGOWORK002	760/515	470/283	356	7016	

Made up of:

qty.	description
1	Swivel arm for upright
1	Monitor support plate with VESA standard
1	Panel for Picking Box
3	Bar mount for Picking Box bins size 1/2
3	Kit of 4 Picking Box Air bins size 1



SWIVEL ARM WITH PICKING BOX

ART.	W mm	D mm	H mm	RAL	
ERGOWORK003	826/515	470/348	356	7016	

Made up of:

qty.	description
1	Swivel arm for upright
1	Monitor support plate with VESA standard
1	Panel for Picking Box
2	Bar mount for Picking Box bins size 1/2
1	Kit of 3 Picking Box Air bins size 2
1	Kit of 4 Picking Box Air bins size 1



SWIVEL ARM WITH VISUAL BOX

ART.	W mm	D mm	H mm	RAL	
ERGOWORK004	738/612	601/294	390	7016	

Made up of:

qty.	description
1	Swivel arm for upright
1	Monitor support plate with VESA standard
1	Panel for Visual Box
1	Visual Box cabinet with 5 drawers
2	Visual Box cabinet with 6 drawers



MONITOR SUPPORT PLATE WITH BRACKETS

ART.	W mm	D mm	H mm	RAL	
ERGOWORK014	225/129	119/225	225	7016	

Made up of:

qty.	description
1	Pair of L-shaped brackets
1	Joint for plate
1	Monitor support plate with VESA standard



PERFORATED PANEL WITH HINGES

ART.	W mm	D mm	H mm	RAL	
ERGOWORK007	647	60	496	7035	

Made up of:

qty.	description
1	Perforated panel/shelf with box-stop edge
1	Hinge kit for perforated panel



SWIVEL ARM WITH INCLINED TRAY

ART.	W mm	D mm	H mm	RAL	
ERGOWORK005	674/522	425/470	194	7016	

Made up of:

qty.	description
1	Swivel arm for upright
1	Inclined tray



SWIVEL ARM WITH MONITOR SUPPORT PLATE

ART.	W mm	D mm	H mm	RAL	
ERGOWORK001	652/330	225/225	225	7016	

Made up of:

qty.	description
1	Swivel arm for upright
1	Joint for plate
1	Monitor support plate with VESA standard



■ RAL 7016

■ RAL 7035



CONFIGURE 

ART.	W mm	D mm	H mm	 without wheels	 wheel set	RAL	
CLEVER1031	1036	672	1428	300	300	7035	

Made up of:

qty.	description	qty.	description
1	Unassembled trolley without wheels	1	Profile with base for worktop
1	Wooden worktop with supports	1	Pair of L-shaped brackets
2	Perforated side panel	1	Joint for plate
1	Perforated rear panel	1	Monitor support plate with VESA standard
1	Pair of hinged doors	1	Non-marking synthetic rubber wheels kit Ø 125 mm



SWIVEL ARM WITH INCLINED TRAY

ART.	W mm	D mm	H mm	RAL	
ERGOWORK013	745/521	425/480	552	7016	

Made up of:

qty.	description
1	Profile with base for worktop
1	Swivel arm for profile
1	Inclined tray

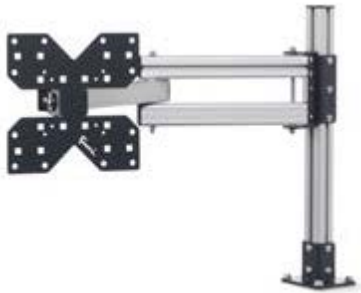

SWIVEL ARM WITH MONITOR SUPPORT PLATE

ART.	W mm	D mm	H mm	RAL	
ERGOWORK009	724/402	225/192	550	7016	

Made up of:

qty.	description
1	Profile with base for worktop
1	Swivel arm for profile
1	Joint for plate
1	Monitor support plate with VESA standard



PROFILE WITH MONITOR SUPPORT PLATE

ART.	W mm	D mm	H mm	RAL	
ERGOWORK008	225/199	151/225	560	7016	

Made up of:

qty.	description
1	Profile with base for worktop
1	Pair of L-shaped brackets
1	Joint for plate
1	Monitor support plate with VESA standard



LOAD CAPACITY



RAL 7016



RAL 7035



SWIVEL ARM WITH PICKING BOX

ART.	W mm	D mm	H mm	RAL	
ERGOWORK010	832/515	470/300	628	7016	

Made up of:

qty.	description
1	Profile with base for worktop
1	Swivel arm for profile
1	Monitor support plate with VESA standard
1	Panel for Picking Box
3	Bar mount for Picking Box bins size 1/2
3	Kit of 4 Picking Box Air bins size 1



SWIVEL ARM WITH PICKING BOX

ART.	W mm	D mm	H mm	RAL	
ERGOWORK011	898/515	470/365	628	7016	

Made up of:

qty.	description
1	Profile with base for worktop
1	Swivel arm for profile
1	Monitor support plate with VESA standard
1	Panel for Picking Box
2	Bar mount for Picking Box bins size 1/2
1	Kit of 3 Picking Box Air bins size 2
1	Kit of 4 Picking Box Air bins size 1



SWIVEL ARM WITH VISUAL BOX

ART.	W mm	D mm	H mm	RAL	
ERGOWORK012	808/601	601/275	668	7016	

Made up of:

qty.	description
1	Profile with base for worktop
1	Swivel arm for profile
1	Monitor support plate with VESA standard
1	Panel for Visual Box
1	Visual Box cabinet with 5 drawers
2	Visual Box cabinet with 6 drawers



CONFIGURE



ART.	W mm	D mm	H mm	KG	RAL	
MASTERBR2008	3347	750	1985/2360	1000	7035+7016	

Made up of:

qty.	description	qty.	description
1	Unassembled workbench with 40 mm multiplex worktop	1	Differential magnetic-thermal circuit breaker
1	Cover for multiplex worktop	1	Wieland Schuko/FR connection cable
1	Cabinet W=560 mm with 4 drawers 1x75 2x150 1x200	1	Reversible sanitiser-bottle holder
1	Cabinet W=560 mm configured for door with 1 adjustable shelf	1	Glove dispenser
1	Left full door H=600 mm with Dark Grey handle	1	Roll holder kit with roll Ø=240 mm
2	Additional half-shelf W=560 mm	4	Kit of 2 Picking Box Air bins size 3A2
1	Kit with 2 dual-slotted uprights for workbenches	2	Perforated panel/shelf with box-stop edge
1	Kit with 2 inclined supports with track	2	Hinge kit for perforated panel
1	Supplementary track with fittings	8	Bar mount for Picking Box bins size 1/2
1	Double lamp	4	Kit of 4 Picking Box Air bins size 1
1	Kit with 3 perforated panels/shelves with 2 box-stop edges	4	Kit of 3 Picking Box Air bins size 2
1	Electric perforated panel	2	Profile with base for worktop
2	Schuko 2-socket power strip	2	Swivel arm for profile
1	Schuko 4-socket power strip	1	Inclined tray
1	Monitor support plate with VESA standard	1	Joint for plate



LOAD CAPACITY



RAL 7035 + RAL 7016



RAL 7016

COMPONENTS

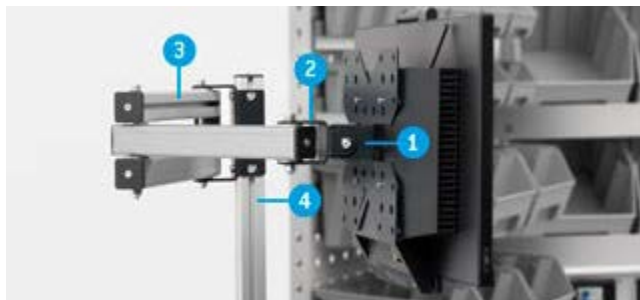

1. Monitor support plate with VESA standard
2. Joint for plate
3. Swivel arm for profile
4. Profile with base for worktop

1. Monitor support plate with VESA standard
2. Panel for Visual Box
3. Visual Box cabinet with 6 drawers
4. Swivel arm for upright



SWIVEL ARM FOR UPRIGHT

ART.	W mm	D mm	H mm	Rotation angle °	material	KG	RAL	
FBL74100039	580/330	72/97	158	240	Aluminium	20	7016	



SWIVEL ARM FOR PROFILE

To be used on profile with base for worktop

ART.	W mm	D mm	H mm	Rotation angle °	material	KG	RAL	
FBL74180039	621/371	57/90	158	260	Aluminium	20	7016	



PROFILE WITH BASE FOR WORKTOP

ART.	W mm	D mm	H mm	suitable for	material	KG	RAL	
FBL74160039	100	100	504	Multiplex worktop-MDF worktop with rubber coating	Aluminium	20	7016	



PANEL FOR VISUAL BOX

To be used with monitor support plate

ART.	W mm	D mm	H mm	Hole dim. mm	Pitch mm	KG	RAL	
FBL74150039	601	31	313	10x10	38	20	7016	

See Visual Box page 405

COMPONENTS



MONITOR SUPPORT PLATE WITH VESA STANDARD

Can be oriented on one axis

ART.	W mm	D mm	H mm	RAL	
FBL74120039	225	50	225	7016	



JOINT FOR PLATE

To be used with a monitor support plate to be oriented on two axes

ART.	W mm	D mm	H mm	RAL	
FBL74110039	91	67	51	7016	



PAIR OF L-SHAPED BRACKETS

To be used with monitor support plate

ART.	W mm	D mm	H mm	RAL	
FBL74170039	38	36	32	7016	



INCLINED TRAY

ART.	W mm	D mm	H mm	RAL	
FBL74130039	425	308	135	7016	



1. Inclined tray
2. Swivel arm for profile
3. Profile with base for worktop



LOAD CAPACITY



RAL 7016



ALUMINIUM

COMPONENTS



PANEL FOR PICKING BOX

To be used with monitor support plate

ART.	W mm	D mm	H mm	suitable for	KG	RAL
FBL74140039	470	12	356	Picking Box bin size 1/2	20	7016



BAR MOUNT FOR PICKING BOX BINS SIZE 1/2

ART.	W mm	D mm	H mm	Finish
FBLIT020099	445	14	89	Galvanised

KIT OF 4 PICKING BOX AIR BINS SIZE 1

ART.	overall dimensions			colour
	W mm	D mm	H mm	
FBLIT0600LQ	108	173	76	Grey
FBLIT060039	108	173	76	Black
FBLIT060032	108	173	76	Blue
FBLIT06001Z	108	173	76	Yellow
FBLIT06002Y	108	173	76	Red
FBLIT06004Q	108	173	76	Green



KIT OF 3 PICKING BOX AIR BINS SIZE 2

ART.	overall dimensions			colour
	W mm	D mm	H mm	
FBLIT0610LQ	160	234	127	Grey
FBLIT061039	160	234	127	Black
FBLIT061032	160	234	127	Blue
FBLIT06101Z	160	234	127	Yellow
FBLIT06102Y	160	234	127	Red
FBLIT06104Q	160	234	127	Green

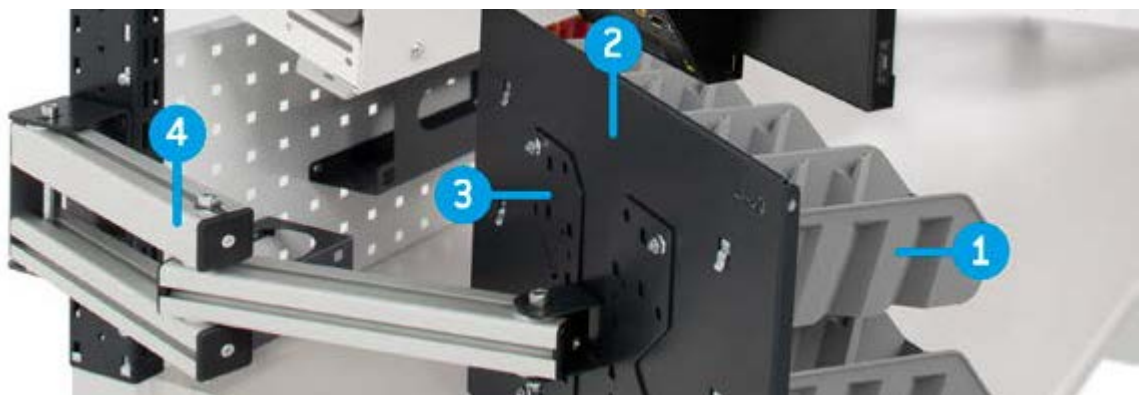

1. Bar mount for Picking Box bins size 1/2
Kit of 4 Picking Box Air bins size 1
2. Panel for Picking Box
3. Monitor support plate with VESA standard
4. Swivel arm for upright



ART.	W mm	D mm	H mm	KG	RAL
MASTERBR1509	1706/3016	750	1985/2360	1000	7035+7016

Made up of:

qty.	description	qty.	description
1	Unassembled workbench with 40 mm multiplex worktop	3	Swivel arm for upright
1	Cabinet W=560 mm with 5 drawers 1x75 3x100 1x200	1	Joint for plate
2	Top/bottom shelf W=560 mm	2	Monitor support plate with VESA standard
1	Left full door H=600 mm with Dark Grey handle	1	Inclined tray
1	Internal shelf W=558 mm	1	Panel for Visual Box
1	Support for intermediate half-shelf	1	Visual Box cabinet with 5 drawers
2	Perforated side panel	2	Visual Box cabinet with 6 drawers
1	Kit with 2 dual-slotted uprights for workbenches	1	Bin with 30 l capacity
1	Kit with 2 perforated panels/shelves with 1 box-stop edge	2	Angled 2-space spray-can holder
1	Kit with 2 inclined supports with track	1	A4 document-holder pocket
1	Double lamp	1	Roll holder kit with Ø 130 mm roll
1	Wall unit with vasistas flip up opening without lock	3	Unipok tool hook - 30-piece pack
1	LED strip	2	Bar mount for Picking Box bins size 1/2
1	Pair of brackets for fastening wall unit to dual-slotted uprights	1	Kit of 4 Picking Box Air bins size 1
1	Kit of 3 Picking Box Air bins size 2		

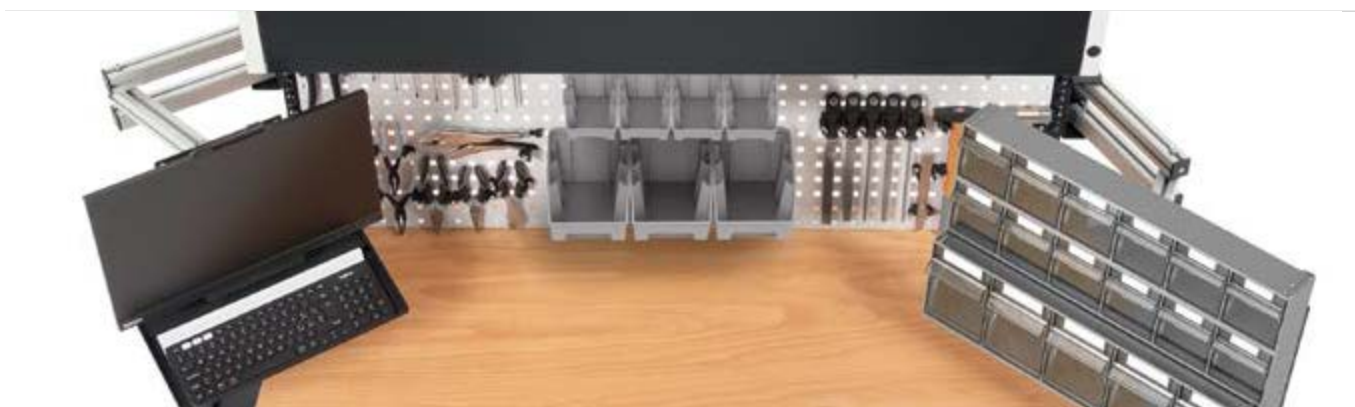

LOAD CAPACITY



RAL 7035 + RAL 7016



RAL 7016



GALVANISED

COMPONENTS



PERFORATED PANEL/SHELF

ART.	W mm	D mm	H mm	Hole dim. mm	Pitch mm	RAL	
FBL76070008	647	40	304	10x10	38	7035	
FBL76070004	647	40	304	10x10	38	5012	



PERFORATED PANEL/SHELF WITH BOX-STOP EDGE

ART.	W mm	D mm	H mm	Hole dim. mm	Pitch mm	RAL	
FBL76080108	647	40	456	10x10	38	7035	
FBL76080104	647	40	456	10x10	38	5012	



HINGE KIT FOR PERFORATED PANEL

ART.	W mm	D mm	H mm	KG	
FBL7600011F	76	38	64	60	

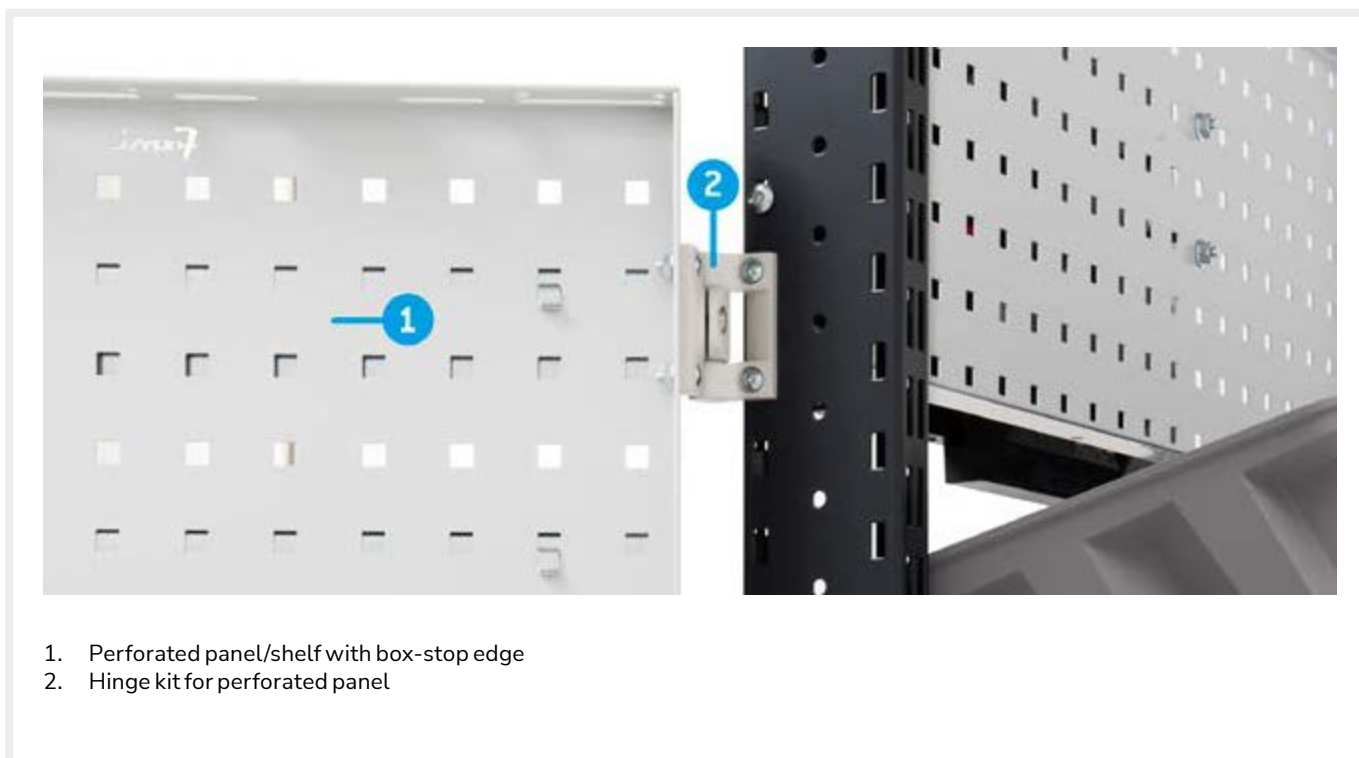

1. Perforated panel/shelf with box-stop edge
2. Hinge kit for perforated panel



CONFIGURE



ART.	W mm	D mm	H mm	KG	RAL
DYNAMIC1505	1497/1672	780	1983/2383	400	7035+7016

Made up of:

qty.	description	qty.	description
1	Electrically adjustable unassembled workbench	1	Differential magnetic-thermal circuit breaker
1	Cabinet W=500 mm with 1 drawer H=150 mm	1	Schuko 4-socket power strip
1	Cover for cabinet W=500 mm	2	Schuko 2-socket power strip
1	Pair of supports for cabinet	1	Wieland Schuko/FR connection cable
1	Additional power strip frame with end caps and corner elements	1	Pair of L-shaped brackets
1	Kit with 2 dual-slotted uprights for workbenches	1	Joint for plate
1	Pair of supports for perforated panel W=1000 mm	1	Monitor support plate with VESA standard
1	Kit with 2 inclined supports with track	2	Perforated panel/shelf with box-stop edge
1	Double lamp	2	Hinge kit for perforated panel
1	Kit with 3 perforated panels/shelves with 2 box-stop edges	6	Bar mount for Picking Box bins size 1/2
1	Electric perforated panel	2	Kit of 4 Picking Box Air bins size 1
4	Kit of 2 Picking Box Air bins size 3A2	4	Kit of 3 Picking Box Air bins size 2
2	Angled 2-space spray-can holder		



LOAD CAPACITY



RAL 7035 + RAL 7016



RAL 5012



RAL 7035